

HIGH-FREQUENCY WORDS

Where Will She Go?

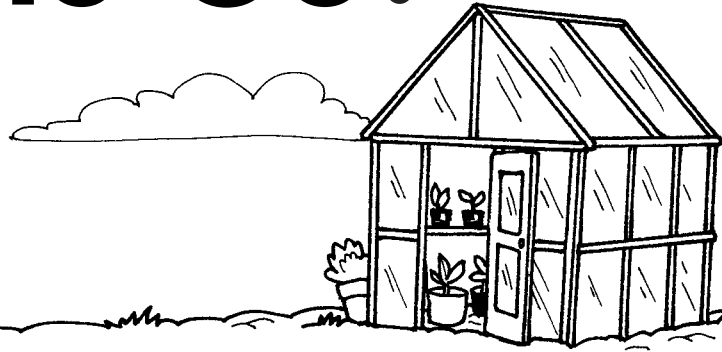

Written by Bill Dinardo • Illustrated by Jane McCreary

www.readinga-z.com

Where Will She Go?

A Reading A-Z High-Frequency Word Book • Set C, Book 5

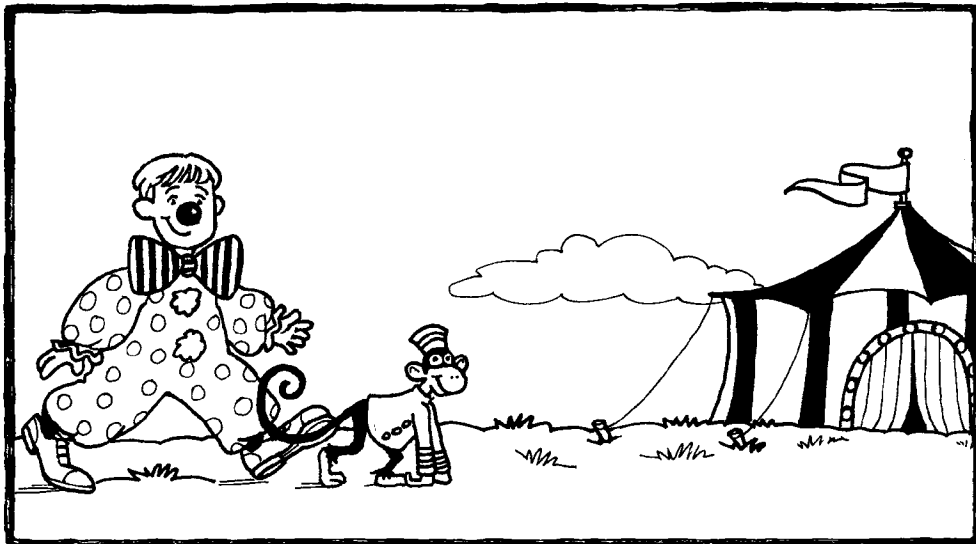

www.readinga-z.com

Where Will She Go?

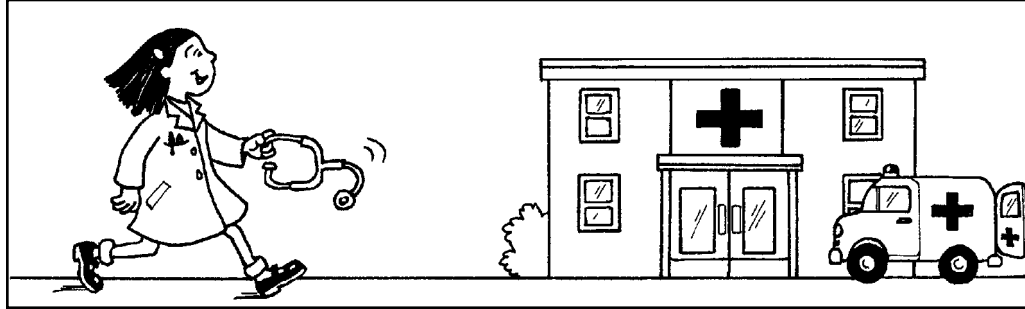

Written by Bill Dinardo
Illustrated by Jane McCreary

www.readinga-z.com

ELEMENTS USED IN THIS BOOK	
New high-frequency words	has, now, then, away
Reviewed high-frequency words	she, her, he, him, a, big, little, with, will, look, like, go, to, the
Story words	drum, hammer, stethoscope, monkey, helmet, airplane, plant, spoon, musician, carpenter, doctor, clown, firefighter, pilot, gardener, chef, concert, workshop, hospital, circus, fire station, airport, greenhouse, restaurant

Where Will She Go?
High-Frequency Word Book, Set C, Book 5
© 2003 Learning Page, Inc.
Written by Bill Dinardo
Illustrated by Jane McCreary
ReadingA-Z™
© Learning Page, Inc.
All rights reserved.
Learning Page
1630 E. River Road #121
Tucson, AZ 85718
www.readinga-z.com

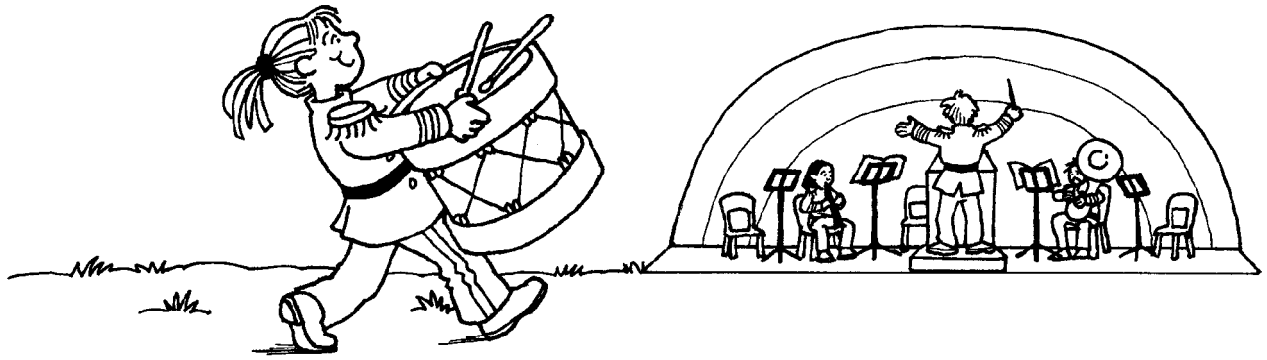

She has a big  with her.

drum

Now she will look like a  .

musician

Then she will go away to a  .

concert

3

workshop

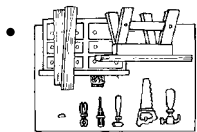

Then he will go away to the

carpenter



Now he will look like a

hammer

He has a big with him.

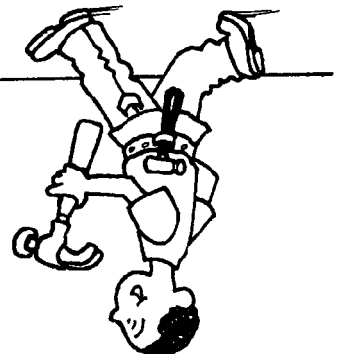
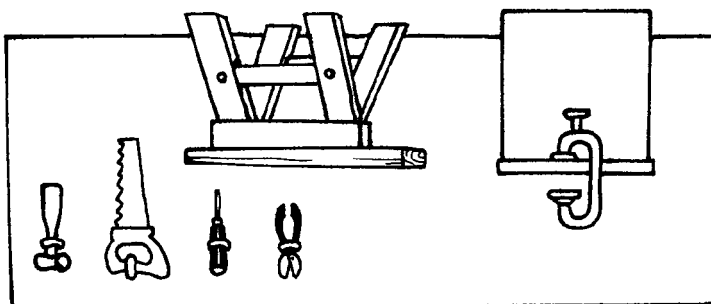
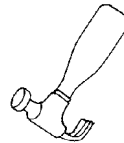

4

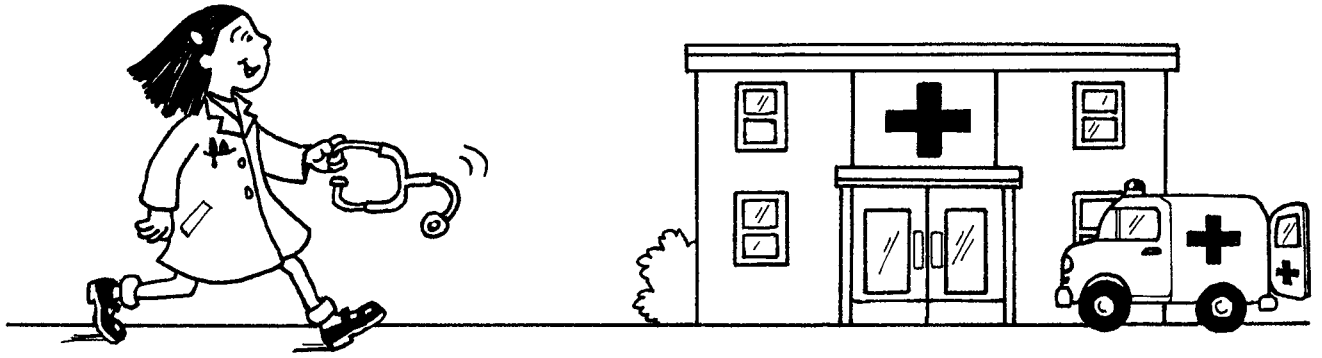

She has a little  with her.

stethoscope

Now she will look like a  .

doctor

Then she will go away to a  .

hospital

5

Then he will go away to the  .

circus

Now he will look like a  .

clown

He has a little  with him.

monkey

9

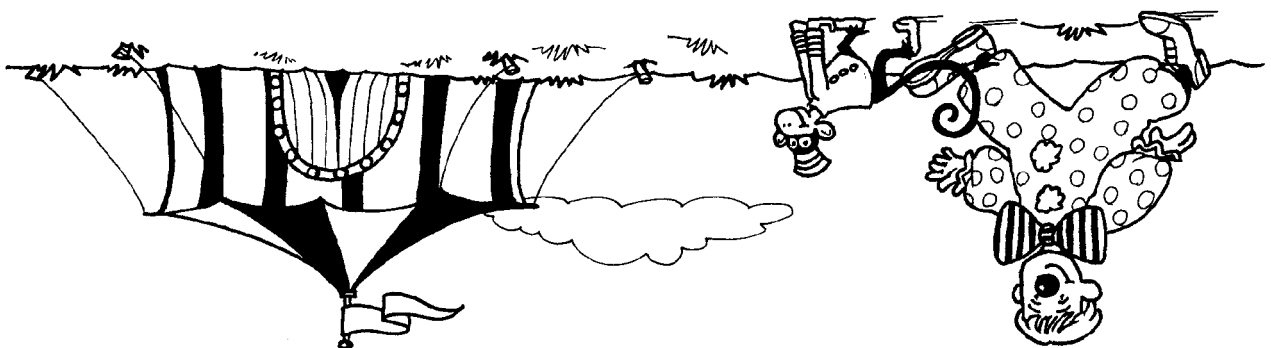

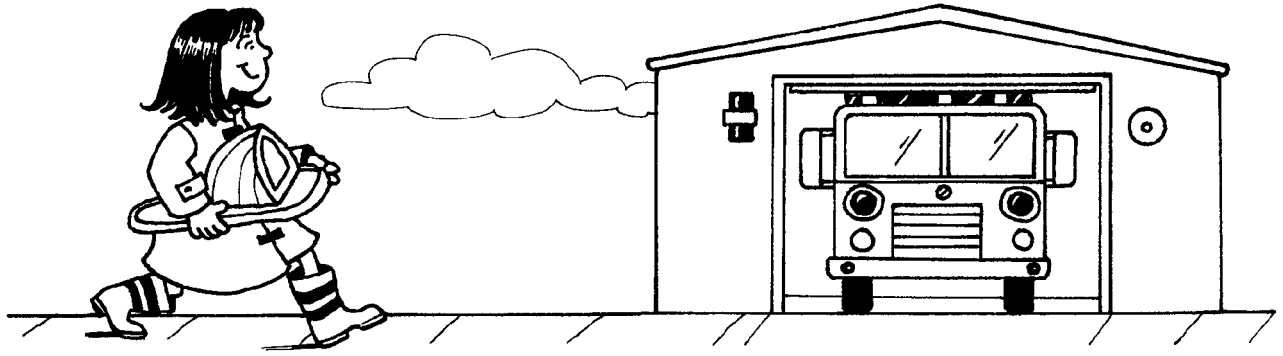

She has a big

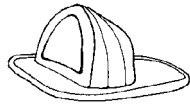

with her.

helmet

Now she will look like a



firefighter

Then she will go away to a

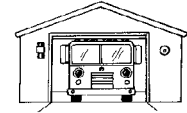

fire station

7

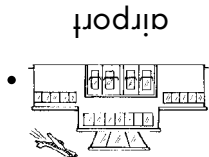

airport

Then he will go away to the

8



pilot

Now he will look like a

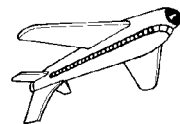

airplane

with him.

He has a little

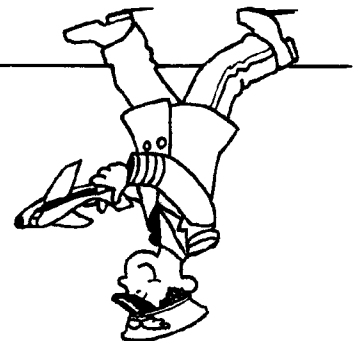
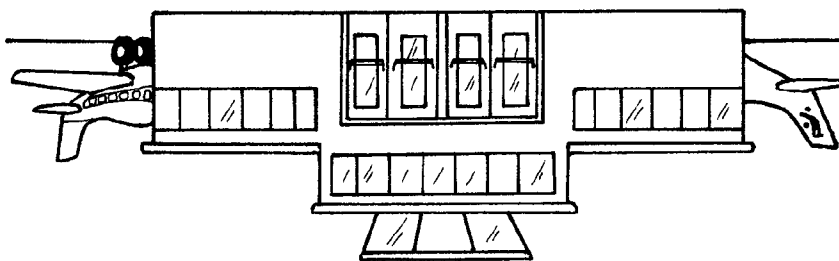

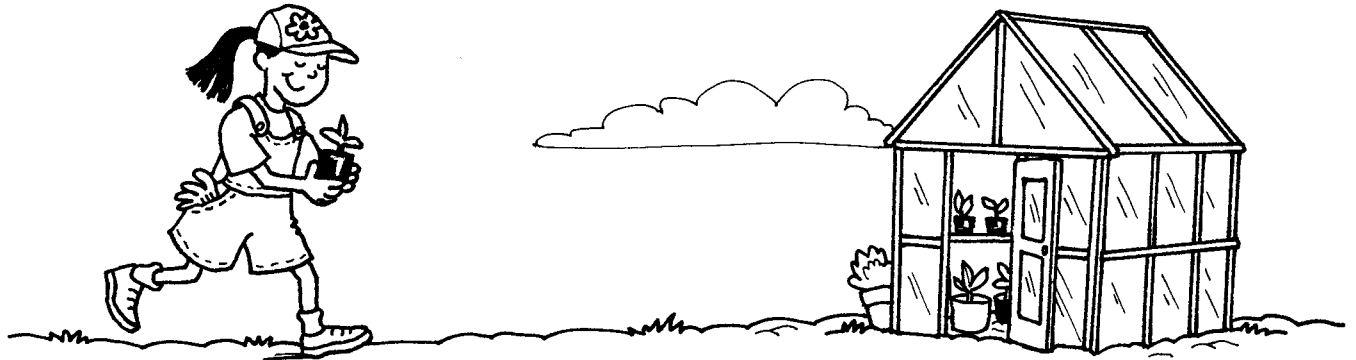

She has a little  with her.
plant

Now she will look like a .
gardener

Then she will go away to a .
greenhouse

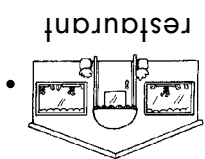

restaurant

Then he will go away to the



chef

Now he will look like a



spoon

He has a big with him.

